

BAN-
QUET
CONFERENCE-
RENTAL
EQUIP-
MENT

 **INFINITY**
HOTEL SUPPLIES LLC

EVINOKS



CONTENTS



09	BANQUET CHAIRS
42	CHAIR TRANSPORT TROLLEY
45	BANQUET TABLES
53	TABLE TRANSPORT TROLLEY
55	CONFERENCE TABLES
68	BISTRO TABLES
71	FOLDABLE DISPLAY TABLES
	PROJECTION TABLE
72	BUFFET TABLES
73	NESTING TABLES
74	STAGES&STEPS
77	STAGE TRANSPORT TROLLEY
78	DANCE FLOOR
79	DANCE FLOOR TRANSPORT TROLLEY
80	LECTERNS
82	FOLDING SCREEN
85	BARRIER&ROPES



INNOVATIVE AND GREEN



EVINOKS

Having a 23.600 m² indoor area with a live showroom, production, offices, the factory creates an environmental and innovative working atmosphere both for the community and the employees as well as saving energy, water and heat. The facility was built up completely with recycled materials according to Green Building Standards. EVINOKS facility is capable of being a candidate to the LEEDS Gold Green Building status. Evinoks has international (CE-SASO-ISO 9001) certification and is the supplier of international and national chains like Sheraton, Hilton, Dedeman, Ramada, Crown Plaza, Marriott, Radisson, Rixos, Mövenpick, Holiday Inn, Rotana, Divan etc. In search of innovation and excellence with team spirit, EVINOKS makes a difference in every product produced. "As regard of the technology ; Evinoks is proud of its metal and wooden craftsmanship as well as the modernised machinery park recently renovated with the CNC controlled metal & wood processing machines, and robot welding.



BANQUET CHAIRS



Evinoks; offers a wide range of chair collection with features like various frame finishes & colour options, feet gliders move easily both on carpet and hard floors. Fire retardant fabric is an option. Not all the fabrics are fire retardant. The upholstery of the chairs can be chosen from the Evinoks fabric collection and sewed with care by our experienced craftsmanship. All the chairs have a CFC free polyurethane seating plate that are supported by an high density injection moulded plastics. Evinoks has the technology of the 6 axis fully automatic metal bending and the robot welding from one point to manufacture quality, strong and ergonomic banqueting & conference chairs at competitive prices.



SELECT

Select is designed to be a delicate & contemporary model to bring an esthetics to your venues. It has a flex lumbar support to provide and ergonomic comfort and quality.

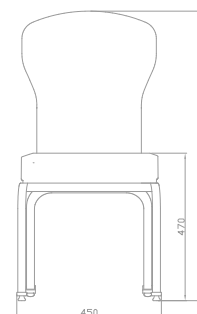

BSY 3030

90 47 47 8 45 8 648 pcs

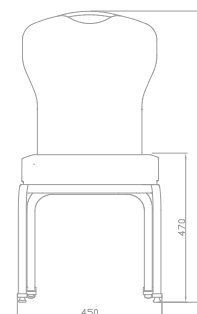

BSY 3030

90 47 47 8 45 8 648 pcs



Different handle options

SELECT

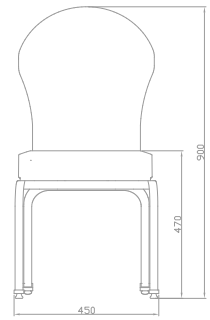

BSY 3032

90 47 47 8 45 8 648 pcs

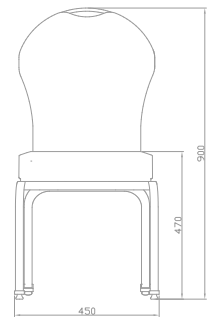

BSY 3032

90 47 47 8 45 8 648 pcs



Select serie chairs' flexibility does not end thanks to the spring steel used at the back.

SELECT

Stack button

Swivel type feet is an option to the moulded clear feet.

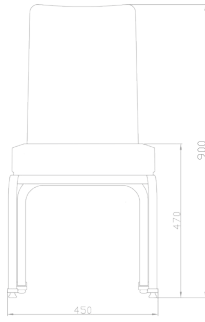

BSY 3034

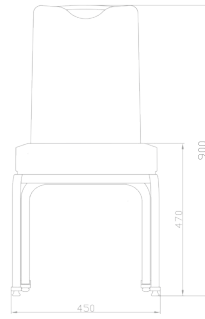

BSY 3034



SELECT

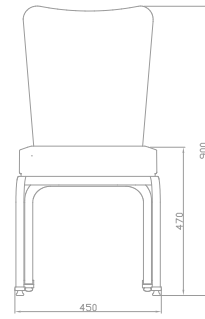

BSY 3036

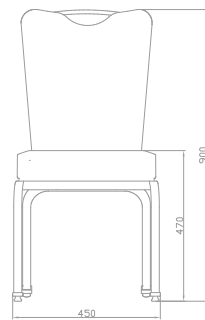

BSY 3036



Select model can be stackable up to 8 chairs.



SELECT



SELECT

5 Different back types...

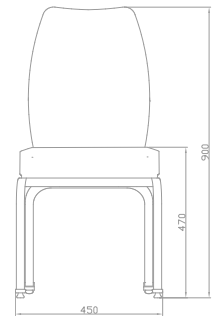

BSY 3038

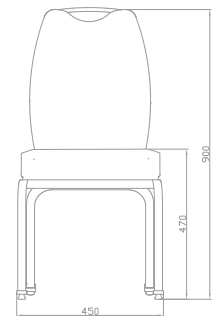

BSY 3038



A high-angle photograph of two purple upholstered chairs with silver metal frames, positioned under a dark, solid-colored table. The chairs are facing away from the camera. The floor is a light, neutral color, and the lighting creates long, soft shadows of the chairs and the table's legs. The overall mood is minimalist and modern.

SELECT

SELECT

All select models can be with castors. The tilting mechanism and adjustable height provide comfort for boardrooms.



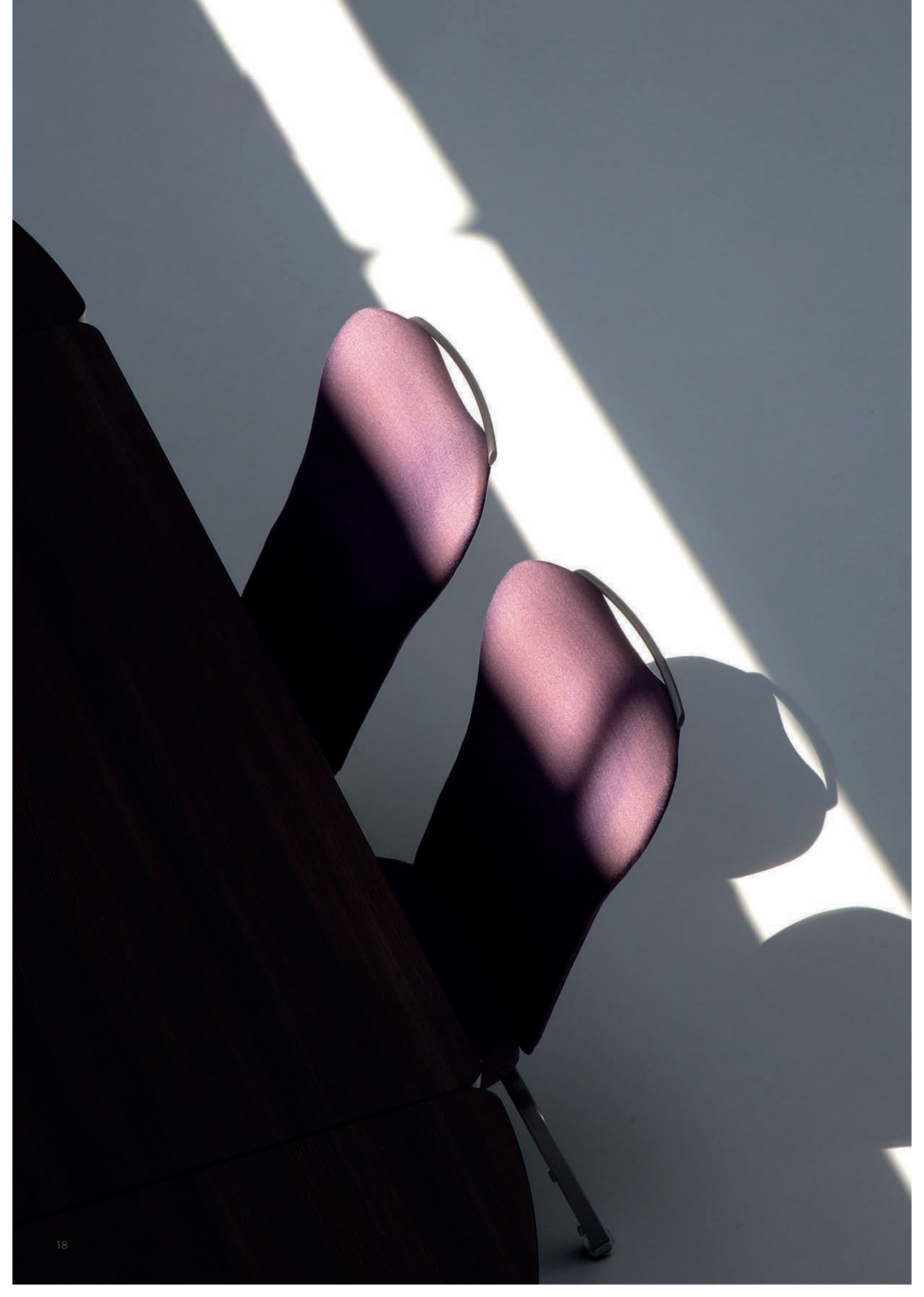

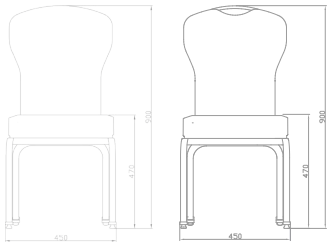

BSY 3030



SELECT

Arms available on all models.

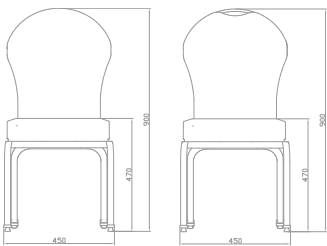

BSY 3032

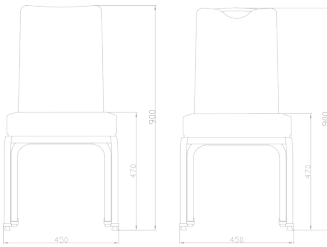

BSY 3034

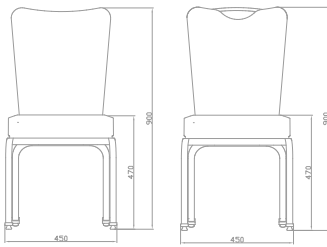

BSY 3036

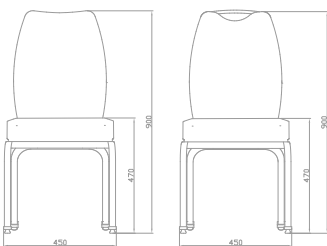

BSY 3038





CASUAL

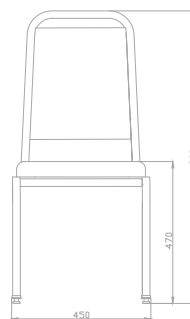

BSE 100

90 47 47 10 45 5 680pcs

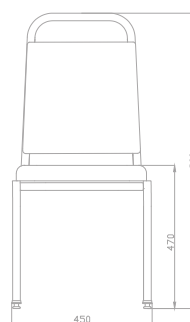

BSE 102

90 47 47 10 45 5 680pcs



CASUAL

The moulded clear type or swivel type gliders can be used both on carpet and solid surfaces. And have been created after many long lasting endeavours.



All models can stack 10 chairs high and move with chair trolley. (See page 43 for more information.)

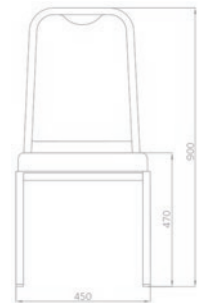

BSE 104

90 47 47 10 45 5 680pcs

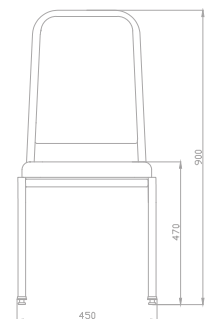

BSE 106

90 47 47 10 45 5 680pcs

CASUAL

All models can be stackable up to 10 chairs high.



Swivel Type Feet Glides



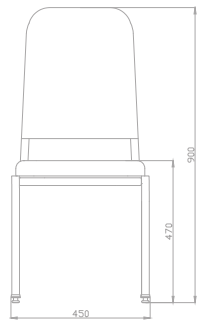

BSE 108

90 47 47 10 45 5 680pcs

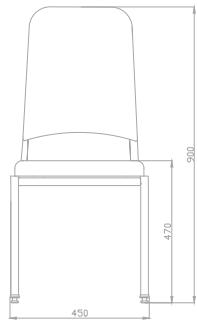

BSE 110

90 47 47 10 45 5 680pcs

CASUAL



Stack button

The parachute type glides does not come off.



CHOICE



BSE 300

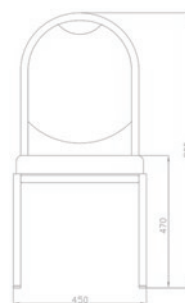

90 47 47 10 45 5 680pcs



BSE 302

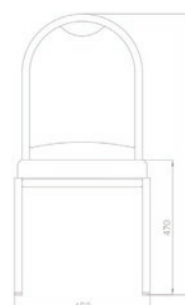

90 47 47 10 45 5 680pcs

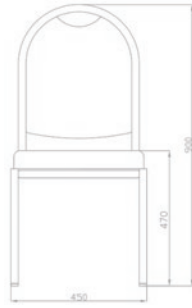

BSE 304

H H H H A 5 680pcs
90 47 47 10 45 5 680pcs

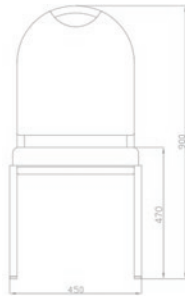

BSE 306

H H H H A 5 680pcs
90 47 47 10 45 5 680pcs



CHOICE

It's a very comfortable chair thanks to its large seats.

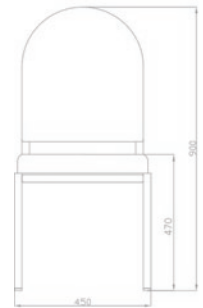

BSE 308

H H H H A 5 680pcs
90 47 47 10 45 5 680pcs

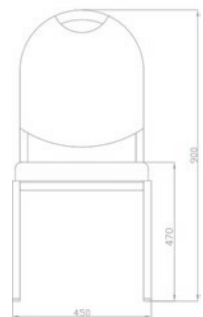

BSE 310

H H H H A 5 680pcs
90 47 47 10 45 5 680pcs

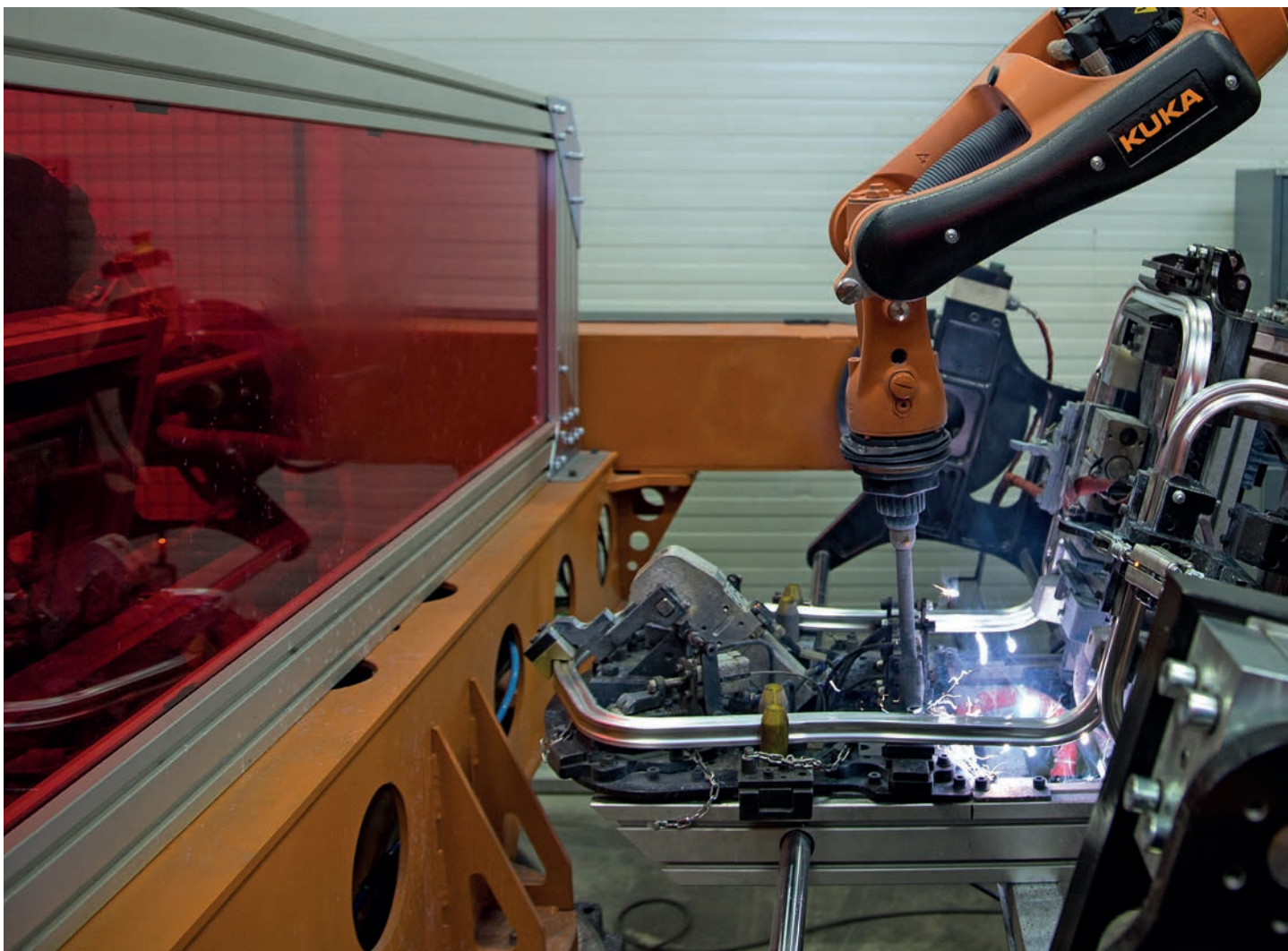

CORNER

A plump design with the sharp lines gives a very chic image to your halls. Moulded plastic corner detail is the same colour with the profile.



BSE 250

93 47 47 10 45 5 680pcs



CORNER



BSE 252

HHH A MC 680pcs
93 47 47 10 45 5

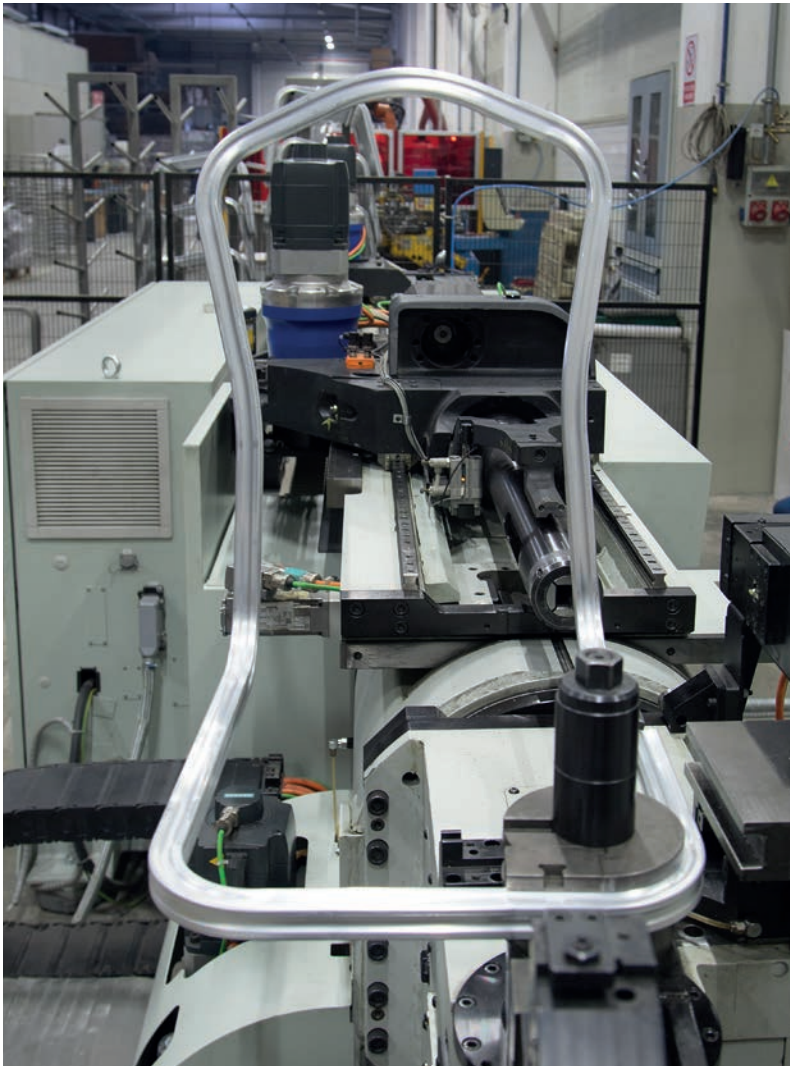

DAILY

A Highly preferred model with various seatback options.



BSE 200

90 47 47 10 45 5 680pcs

Evinoks aluminium chair frames are bended by 6 axes tube bending machine in one-piece.



LUCKY

This model is a very "Lucky" one due to its lines and being the most sold model. Plump construction enables a comfortable seating.



LUCKY

The parachute type glides does not come off.

All models will stack 10 high.

LUCKY

Easy to carry with built in hand hold. It is a very comfortable chair thanks to it's seats that can be produced from polyurethane foam.



*ERGO back feature can only be applied in Lucky models.



PYRAMID

A very handy classical model in line comply with the decor in your halls.

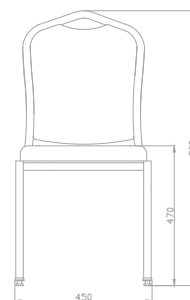

BSE 150

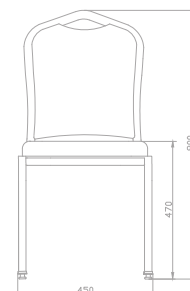

BSE 152



PYRAMID



BSE 154

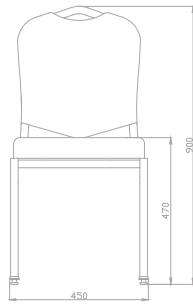

BSE 156

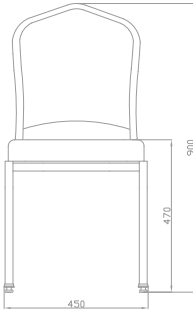

BSE 158

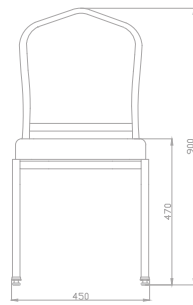

BSE 160

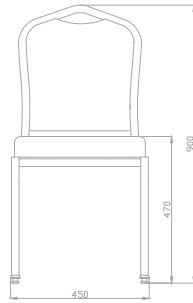

The stack button.

Perfect Details

The swivel glides.



UOVO

A model with oval lines makes it to have a soft, plump and shining look with its high seatback especially.





BSE 450

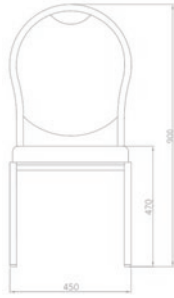

h h h h A kg t
93 47 47 10 45 5 680pcs



BSE 452

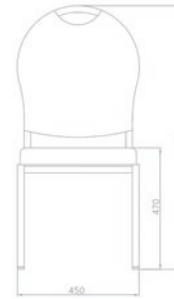

h h h h A kg t
93 47 47 10 45 5 680pcs



BSE 454



h h h h A kg t
93 47 47 10 45 5 680pcs



BSE 456

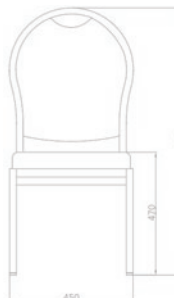

h h h h A kg t
93 47 47 10 45 5 680pcs



BSE 610

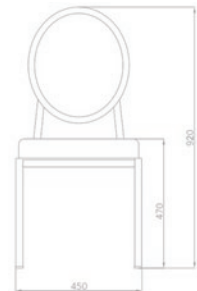

h h h h A kg t
92 47 47 10 45 5 680pcs

Y02

Detachable
writing desk.

Patented !
Practical connection with
Magic-Bolt.

Alternative hidden wire connection
while not in use.



Y02

Detachable
writing desk.

WRITING DESK & MAGIC BOLT

No need to lift the
chairs to connect
them anymore!
Thanks to Magic-Bolt.
Magic bolt is
compatible with
connection like
writing desk .





ARMREST

K01

Welded flat armrest



K02

Welded curved armrest



K03

Detachable armrest



YAYLI SIRT FLEXI BACK

Flexible back can be adaptable to all Evinoks chair models.



Armrest can be applicable to all Evinoks chair models. Add 15 cm to width.



A01

Leg support.

Leg support can be applied to all chair models except the SELECT serie.

Moulded transparent plastic gliders.

K02

Welded curved armrest



Clear Swivel gliders.

CHAIR TRANSPORT TROLLEY

3 wheeled trolley enables the chair to be moved with maximum ease at minimum effort.





BST 311

128x64x110cm
 40x64x125cm (closed / kapalı)
 Taşıma kapasitesi 10 adet
 Epoksi boyalı
 Katlanabilir
 Capacity 10 chairs.
 Epoxy painted
 Foldable

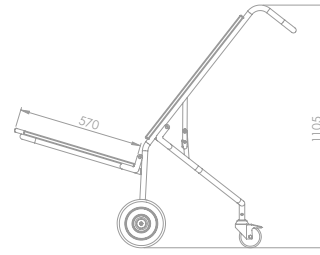
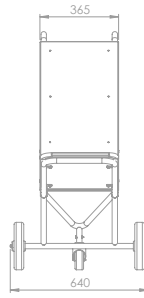

BST 312

128x64x110cm
 40x64x125cm (closed / kapalı)
 Taşıma kapasitesi 8 adet (Select model)
 Epoksi boyalı
 Katlanabilir
 Capacity 8 chairs (for select model).
 Epoxy painted
 Foldable

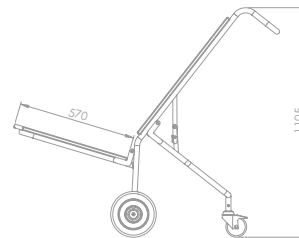
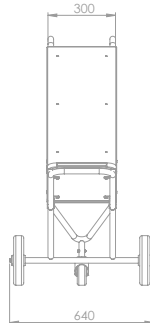



BANQUET TABLES

Design to serve in restaurants, meeting rooms and ball rooms with easy to open/ close legs. Specially designed trolley, enables an ease and safe transportation.

Legs and the frame are made of epoxy powder coated steel and chrome effect paint. BY series; have controlled mechanism from two cross-legs, which is easy to use.

Legs must be stretched behind while closing for security reasons.





BANQUET TABLES

It's an easy and fast operation to open and close the legs with the spring weighed locking mechanism. All models ; have adjustable feet for uneven grounds. Tops can be made of 18 mm mdf-mdflam-plywood -waterproof plywood -flock coated and produced by the CAD controlled panel shape & edgbanding machine centre.



Flock coated top.

One-Touch System



The legs can be easily folded/unfolded by pulling the trigger of the double locking mechanism.

Evinoks patented aluminium edge provides maximum protection.





BANQUET TABLES

Edges can be produced; with the Evinoks patented aluminium or pvc band protection.



One-Touch System

The legs can be easily folded/unfolded by pulling the trigger of the double locking mechanism.

MDF laminated top.

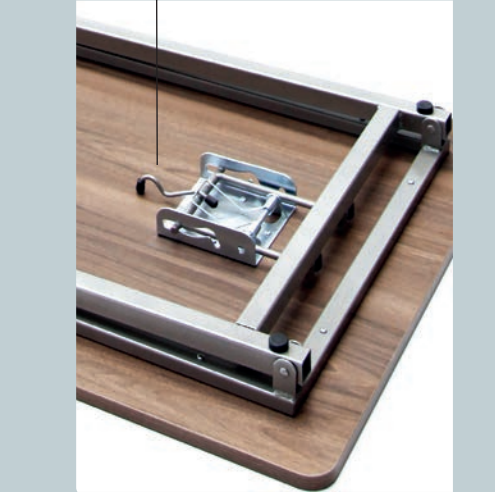

BANKET MASALARI BANQUET TABLES



BYM
Ø150 cm



BYM
120x75 cm



BYK
Ø120/2 cm

CODES OF TOPS



BYK (EPC
BKK (Chrome effect paint

MDF tabla, PVC kenarlı banquet masası







BYM (EPC
BKM (Chrome effect paint
MDF lam top, banquet table with PVC edges



BYL (EPC
BKL (Chrome effect paint
MDF top, banquet table with aluminium edges

*ESB : Epoksi toz boyalı

CODES OF TABLES

Diagram	Code of Chrome paint	Code of EPC	Height (cm)	Capacity (person)
	BKK Ø120 BKK Ø150 BKK Ø180	BYK Ø120 BYK Ø150 BYK Ø180	74	6 8 10
	BKK Ø90/2 BKK Ø120/2 BKK Ø150/2 BKK Ø180/2	BYK Ø90/2 BYK Ø120/2 BYK Ø150/2 BYK Ø180/2	74	2 2 3 4
	BKK Ø90/4 BKK Ø120/4 BKK Ø150/4	BYK Ø90/4 BYK Ø120/4 BYK Ø150/4	74	1 1 1
	BKK Ø270/5 (72° segment)	BYK Ø270/5 (72° segment)	74	3
	BKK 100x60 BKK 100x75	BYK 100x60 BYK 100x75	74	4 4
	BKK 90x90	BYK 90x90	74	2
	BKK 120x45 BKK 120x60 BKK 120x75 BKK 150x45 BKK 150x60 BKK 150x75 BKK 180x45 BKK 180x60 BKK 180x75	BYK 120x45 BYK 120x60 BYK 120x75 BYK 150x45 BYK 150x60 BYK 150x75 BYK 180x45 BYK 180x60 BYK 180x75	74	2 4 4 3 6 6 4 8 8



BYK
90x90 cm



BYK
Ø150/4 cm

*The capacity may reduce if chairs are with armrest.

CODES OF TOPS

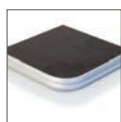

BYE (EPC) **BKE** (Chrome effect paint)
MDF lam top, banquet table with aluminium edges

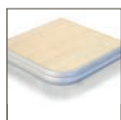

BYO (EPC) **BKO** (Chrome effect paint)
Plywood top, banquet table with aluminium edges



BYS (EPC) **BKS** (Chrome effect paint)
Water-resistant plywood top, banquet table with aluminium edges

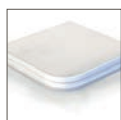

BYF (EPC) **BKF** (Chrome effect paint)
Flock top, banquet table with aluminium edges



BYK
Ø270/5
(72° segment)



Tables do not slide and are protected by PVC straps.

BMT 111

185x75x109cm

Design to store up to six (6) round tables.



BANQUET TABLE TRANSPORT TROLLEY

Panel protecting bumper ensures tables to be transported without any damage.



BMT 211
185x75x109cm

Designed specially for stacking up to 10 rectangular tables.



BMT 211
185x75x109cm



Tables do not slide and are protected by PVC straps during transportation.



CONFERENCE TABLES

It gives a comfort while sitting with its "C", "I", "H" shapes. Not only unwanted accidents have been prevented with its security lock of folding mechanism, but also a high rigidity has been aquired. Your conference halls can have a luxurious appearance with its corner parts and front panels. Edge forms can be chosen among natural wood, PVC band and plastic T-band. Different table top finishes are available. We offer chrome effect paint, stainless steel or epoxy painted legs with colour options. Our architects can provide you with CAD layout as per your request.





STANDARD SERIE

One-Touch System

The legs can be easily folded/unfolded by pulling the trigger of the double locking mechanism.



BCM
180x45



BIM
180x60



BHM
180x75





C

I





H

CODES OF TABLES





STANDARD SERIE C LEG

	Leg C	Code of Chrome paint	Code of Epoxy Powder Coated	Code of Stainless Steel	Height (cm)	Capacity (person)
		BCM Ø90/2	BRM Ø90/2	BCS Ø90/2	74	2
		BCM Ø90/4	BRM Ø90/4	BCS Ø90/4	74	1
		BCM ▷ 45	BRM ▷ 45	BCS ▷ 45	74	1
		BCM 120x45 BCM 150x45 BCM 180x45	BRM 120x45 BRM 150x45 BRM 180x45	BCS 120x45 BCS 150x45 BCS 180x45	74	2 3 4

STANDARD SERIE I LEG

	Ayak Leg I	Code of Chrome paint	Code of Epoxy Powder Coated	Code of Stainless Steel	Height (cm)	Capacity (person)
		BIM Ø120/2	BSM Ø120/2	BIS Ø120/2	74	2
		BIM Ø120/4	BSM Ø120/4	BIS Ø120/4	74	1
		BIM ▷ 60	BSM ▷ 60	BIS ▷ 60	74	1
		BIM 120x60 BIM 150x60 BIM 180x60	BSM 120x60 BSM 150x60 BSM 180x60	BIS 120x60 BIS 150x60 BIS 180x60	74	2 3 4

STANDARD SERIE H LEG

	Leg H	Code of Chrome paint	Code of Epoxy Powder Coated	Code of Stainless Steel	Height (cm)	Capacity (person)
		BHM Ø120/2 BHM Ø150/2	BPM Ø120/2 BPM Ø150/2	BHS Ø120/2 BHS Ø150/2	74	2 3
		BHM Ø150/4	BPM Ø150/4	BHS Ø150/4	74	1
		BHM ▷ 75	BPM ▷ 75	BHS ▷ 75	74	1
		BHM 120x45 BHM 120x60 BHM 120x75 BHM 150x45 BHM 150x60 BHM 150x75 BHM 180x45 BHM 180x60 BHM 180x75	BPM 120x45 BPM 120x60 BPM 120x75 BPM 150x45 BPM 150x60 BPM 150x75 BPM 180x45 BPM 180x60 BPM 180x75	BHS 120x45 BHS 120x60 BHS 120x75 BHS 150x45 BHS 150x60 BHS 150x75 BHS 180x45 BHS 180x60 BHS 180x75	74	2 2 2 3 3 3 4 4 4

CODES OF TOPS



BHK, BCK, BIK Chrome effect
BPK, BRK, BSK EPC
BPS, BRS, BSS Stainless steel)

MDF lam top, conference table with plastic T-bant edge



BHM, BCM, BIM Chrome effect paint
BPM, BRM, BSM EPC
BHS, BCS, BIS Stainless steel

MDF lam top, conference table with plastic T-bant edges

*EPC : Epoxy powder coated



CODES OF PANEL

	Code	Length (cm)	Height (cm)
	BPOM 120	120	30
	BPOK 120	120	30
	BPOM 150	150	30
	BPOK 150	150	30
	BPOM 180	180	30
	BPOK 180	180	30

O : Front Panel
M : MDFLAM+PVC edge
P : MDFLAM+Plastic T-bant



TILT-SLIDE TABLE

EVINOKS patented Tilt-Slide table has an advantage of being two tables in one... The conference table can be used as a banquet table only by sliding the modesty panel.



PATENTED!

TILT-SLIDE TABLE H LEG



Code of Chrome paint	Code of Epoxy Powder Coated	Code of Stainless Steel	Width (cm)	Lenght (cm)	Height (cm)	Height of front panel (cm)
BKHM 135x45/75	BPHM 135x45/75	BSHM 135x45/75	45/75	135	74	30
BKHM 150x45/75	BPHM 150x45/75	BSHM 150x45/75	45/75	150	74	30
BKHM 180x45/75	BPHM 180x45/75	BSHM 180x45/75	45/75	180	74	30
BKHM 135x60/90	BPHM 135x60/90	BSHM 135x60/90	60/90	135	74	30
BKHM 150x60/90	BPHM 150x60/90	BSHM 150x60/90	60/90	150	74	30
BKHM 180x60/90	BPHM 180x60/90	BSHM 180x60/90	60/90	180	74	30

/ MDF lam top, tilt-slide table with PVC edges



BPHM
180x60/90



i

One-Touch System

The legs can be easily folded/unfolded by pulling the trigger of the double locking mechanism.



TABLA KODLARI /CODES OF TOPS



BKHM Chrome effect paint
BPHM EPC
BSHM Stainless steel

MDF lam top, tilt-slide table with PVC edges.

*EPC : Epoxy powder coated



FLEXI SERIE









- Maximum space in sitting lineage
- Minimum space in stacking
- Strong construction on all metal-frame
- Easy and practical folding

FLEXI SERIE WITH POWER MODULE

FLEXI SERIE WITHOUT POWER MODULE



CODES OF TABLES

Diagram	Code of Epoxy powder coating	Code of Stainless Steel	Height (cm)	(kişi) Capacity (person)
	KRT Ø90 KRT Ø120	KPT Ø90 KPT Ø120	74	4 6
	KRT Ø120/2 KRT Ø140/2 KRT Ø150/2 KRT Ø180/2 KRT Ø140/2-D02 KRT Ø150/2-D02 KRT Ø180/2-D02 KRT Ø140/2-D03 KRT Ø150/2-D03 KRT Ø180/2-D03	KPT Ø120/2 KPT Ø140/2 KPT Ø150/2 KPT Ø180/2 KPT Ø140/2-D02 KPT Ø150/2-D02 KPT Ø180/2-D02 KPT Ø140/2-D03 KPT Ø150/2-D03 KPT Ø180/2-D03	74	2 3 3 4 3 3 4 3 3 3 4
	KRT Ø120/4 KRT Ø140/4 KRT Ø150/4	KPT Ø120/4 KPT Ø140/4 KPT Ø150/4	74	1 1 1
	KRT ∇ 60 KRT ∇ 75	KPT ∇ 60 KPT ∇ 75	74	1 1
	KRT Ø270/5 (72° segment)	KPT Ø270/5 (72° segment)	74	3
	KRT 100x60 KRT 100x75 KRT 100x60-D02 KRT 100x75-D02 KRT 100x60-D03 KRT 100x75-D03	KPT 100x60 KPT 100x75 KPT 100x60-D02 KPT 100x75-D02 KPT 100x60-D03 KPT 100x75-D03	74	4 4 4 4 4 4
	KRT 60x60 KRT 75x75 KRT 60x60-D02 KRT 75x75-D02 KRT 60x60-D03 KRT 75x75-D03	KPT 60x60 KPT 75x75 KPT 60x60-D02 KPT 75x75-D02 KPT 60x60-D03 KPT 75x75-D03	74	1 2 1 2 1 2
	KRT 120x60 KRT 120x75 KRT 140x60 KRT 140x75 KRT 150x60 KRT 150x75 KRT 180x60 KRT 180x75 KRT 120x60-D02 KRT 120x75-D02 KRT 140x60-D02 KRT 140x75-D02 KRT 150x60-D02 KRT 150x75-D02 KRT 180x60-D02 KRT 180x75-D02 KRT 120x60-D03 KRT 120x75-D03 KRT 140x60-D03 KRT 140x75-D03 KRT 150x60-D03 KRT 150x75-D03 KRT 180x60-D03 KRT 180x75-D03	KPT 120x60 KPT 120x75 KPT 140x60 KPT 140x75 KPT 150x60 KPT 150x75 KPT 180x60 KPT 180x75 KPT 120x60-D02 KPT 120x75-D02 KPT 140x60-D02 KPT 140x75-D02 KPT 150x60-D02 KPT 150x75-D02 KPT 180x60-D02 KPT 180x75-D02 KPT 120x60-D03 KPT 120x75-D03 KPT 140x60-D03 KPT 140x75-D03 KPT 150x60-D03 KPT 150x75-D03 KPT 180x60-D03 KPT 180x75-D03	74	4 4 6 6 6 6 8 8 4 4 6 6 6 6 8 8 8 4 4 6 6 6 6 8 8
	KRT 75x75x6GEN	KPT 75x75x6GEN	74	6



CODES OF TOPS



KRT EPC
KPT
Laminat panel, banquet table with PVC edges



KRM EPC
KPM (Stainless Steel)
MDF lam panel, banquet table with PVC edges

*EPC : Epoxy powder coated

LUXURY SERIE WITH POWER MODULE



KHM 140x70-D03
140x70x74cm



* Table can be produced with or without power module. Tables with power module end with the "D02" (local product) or "D03" (local product USB dataport).

LUXURY SERIE WITH POWER MODULE

Tables with power modules give you professional service that you need for your meeting-congress organisations. Wheels with break ensure the tables stability. For corner tables, triangle leg connection is used.



KHM 140x70-D02
140x70x74cm

The capacity may reduce if chairs are with armrest.



D02

Evinoks local product power module

D03

Flip top power module with USB flash drive











LUXURY SERIE WITH POWER MODULE

Lux Serie creates quality and classiness to your meeting rooms. Legs are epoxy powder coated or chrome effect paint. Foldable top provides minimum storage space



CODES OF TABLES

Diagram	Code of Chrome Effect Paint	Code of Epoxy Powder Coated	Height (cm)	Capacity (person)
	KKM Ø120/2 KKM Ø140/2 KKM Ø150/2 KKM Ø140/2-D02 KKM Ø150/2-D02 KKM Ø140/2-D03 KKM Ø150/2-D03	KHM Ø120/2 KHM Ø140/2 KHM Ø150/2 KHM Ø140/2-D02 KHM Ø150/2-D02 KHM Ø140/2-D03 KHM Ø150/2-D03	74	2 3 3 3 3 3 3
	KKM Ø120/4 (60 cm enindeki masalar için) KKM Ø140/4 (70 cm enindeki masalar için) KKM Ø150/4 (75 cm enindeki masalar için)	KHM Ø120/4 (60 cm enindeki masalar için) KHM Ø140/4 (70 cm enindeki masalar için) KHM Ø150/4 (75 cm enindeki masalar için)	74	1 1 1
	KKM ▷ 60 KKM ▷ 70 KKM ▷ 75	KHM ▷ 60 KHM ▷ 70 KHM ▷ 75	74	1 1 1
	KKM Ø270/5 (72° segment)	KHM Ø270/5 (72° segment)	74	3
	KKM 100x60 KKM 100x70 KKM 100x75 KKM 100x60-D02 KKM 100x70-D02 KKM 100x75-D02 KKM 100x60-D03 KKM 100x70-D03 KKM 100x75-D03	KHM 100x60 KHM 100x70 KHM 100x75 KHM 100x60-D02 KHM 100x70-D02 KHM 100x75-D02 KHM 100x60-D03 KHM 100x70-D03 KHM 100x75-D03	74	4 4 4 4 4 4 4 4 4 4
	KKM 120x60 KKM 140x60 KKM 140x70 KKM 150x70 KKM 150x75 KKM 180x75 KKM 120x60-D02 KKM 140x60-D02 KKM 140x70-D02 KKM 150x70-D02 KKM 150x75-D02 KKM 180x75-D02 KKM 120x60-D03 KKM 140x60-D03 KKM 140x70-D03 KKM 150x70-D03 KKM 150x75-D03 KKM 180x75-D03	KHM 120x60 KHM 140x60 KHM 140x70 KHM 150x70 KHM 150x75 KHM 180x75 KHM 120x60-D02 KHM 140x60-D02 KHM 140x70-D02 KHM 150x70-D02 KHM 150x75-D02 KHM 180x75-D02 KHM 120x60-D03 KHM 140x60-D03 KHM 140x70-D03 KHM 150x70-D03 KHM 150x75-D03 KHM 180x75-D03	74	2 2 2 2 2 3 2 2 2 2 2 3 2 2 2 2 2 2 2 2 2 3
	KKM 120x60 KKM 140x70 KKM 150x75 KKM 140x70- D02 KKM 150x75- D02 KKM 140x70- D03 KKM 150x75- D03	KHM 120x60 KHM 140x70 KHM 150x75 KHM 140x70- D02 KHM 150x75- D02 KHM 140x70- D03 KHM 150x75- D03	74	3 3 3 3 3 3 3





ELITE SERIE



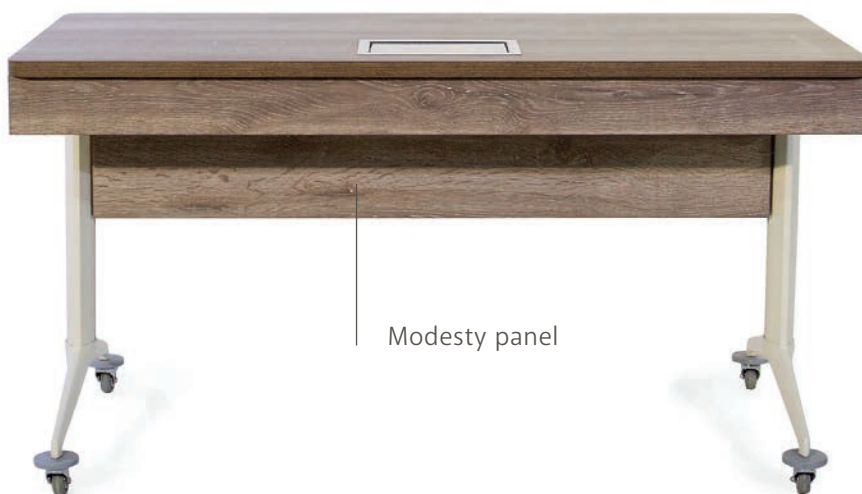





Elit serie comes forward with its new, modern and chic leg design. Soon it's going to be essential for the meeting rooms and conference halls. Thanks to the unique design locking mechanism that provides a practical and an easy folding system for the operators. Easy to handle and minimum storage space.



Modesty panel

- * The capacity may reduce if chairs are with armrest.
- * These codes are for tables without power module. Tables with power module end with the code "D02" or "D03"(USB dataport).

CODES OF TABLES

Diagram	Code of Epoxy powder coated	Height (cm)	Capacity (person)
	ELT Ø90 ELT Ø120	74	4 6
	ELT Ø120/2 ELT Ø140/2 ELT Ø150/2 ELT Ø180/2 ELT Ø140/2-D02 ELT Ø150/2-D02 ELT Ø180/2-D02 ELT Ø140/2-D03 ELT Ø150/2-D03 ELT Ø180/2-D03	74	2 3 3 4 3 3 4 3 3 4
	ELT Ø120/4 ELT Ø140/4 ELT Ø150/4	74	1 1 1
	ELT ▽ 60 ELT ▽ 75	74	1 1
	ELT Ø275/5 (72° segment)	74	3
	ELT 100x60 ELT 100x75 ELT 100x60-D02 ELT 100x75-D02 ELT 100x60-D03 ELT 100x75-D03	74	4 4 4 4 4 4
	ELT 60x60 ELT 75x75 ELT 60x60-D02 ELT 75x75-D02 ELT 60x60-D03 ELT 75x75-D03	74	1 2 1 2 1 2
	ELT 120x60 ELT 120x75 ELT 140x60 ELT 140x75 ELT 150x60 ELT 150x75 ELT 180x60 ELT 180x75 ELT 120x60-D02 ELT 120x75-D02 ELT 140x60-D02 ELT 140x75-D02 ELT 150x60-D02 ELT 150x75-D02 ELT 180x60-D02 ELT 180x75-D02 ELT 120x60-D03 ELT 120x75-D03 ELT 140x60-D03 ELT 140x75-D03 ELT 150x60-D03 ELT 150x75-D03 ELT 180x60-D03 ELT 180x75-D03	74	4 4 6 6 6 6 6 8 8 4 4 6 6 6 6 6 8 8 4 4 6 6 6 6 6 8 8
	ELT 75x75x6GEN	74	6

Foldable top



ELITE SERIE



BISTRO TABLES

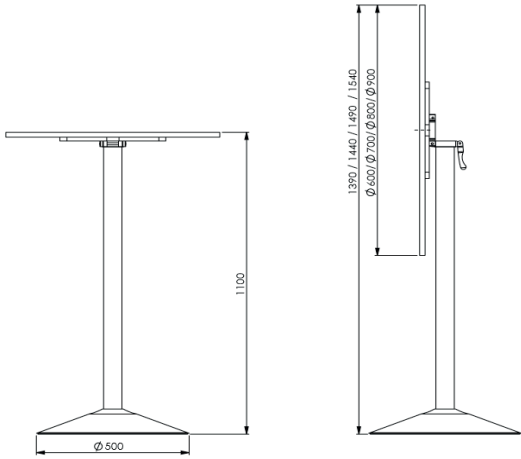

PLA 731
 ø60 cm MDFLAM + PVC
 ø70 cm MDFLAM + PVC
 ø80 cm MDFLAM + PVC
 ø90 cm MDFLAM + PVC
 ø60 cm Temperli Cam / Tempered Glass
 ø70 cm Temperli Cam / Tempered Glass

BISTRO TABLES



PLA 734

- ø60 cm MDFLAM + PVC
- ø70 cm MDFLAM + PVC
- ø80 cm MDFLAM + PVC
- ø90 cm MDFLAM + PVC
- ø60 cm Temperli Cam / Tempered Glass
- ø70 cm Temperli Cam / Tempered Glass

Tilting Mechanism

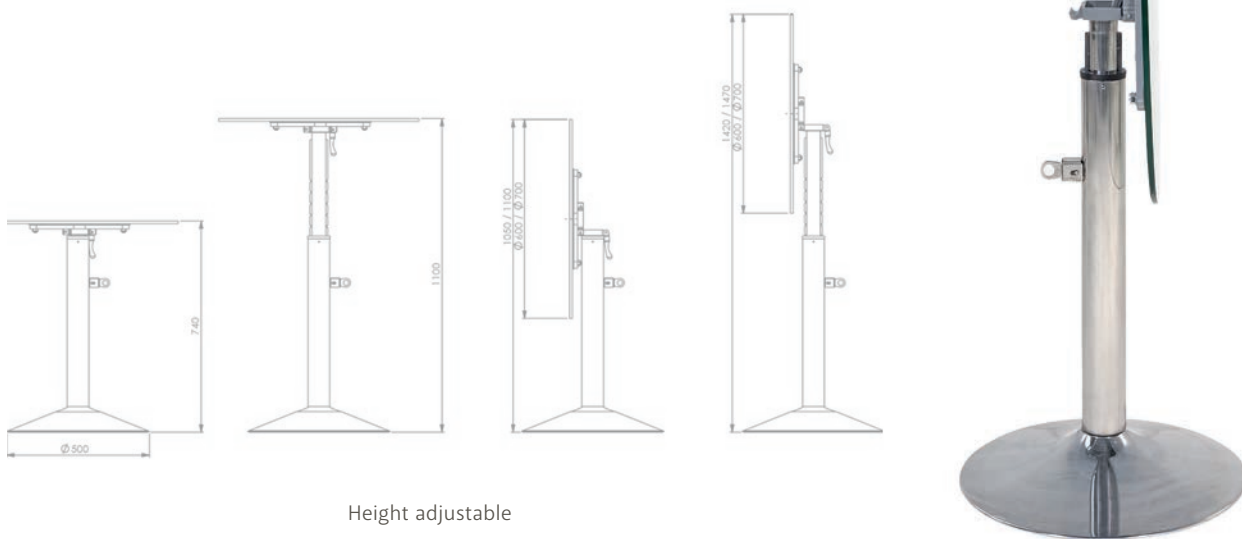

Height adjustable

BISTRO TABLES

A wide range of tables for cocktails & restaurants. Fixed or tilt top, gas lift height adjustable models are with laminate or glass tops.

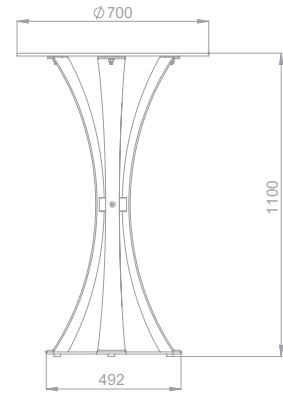
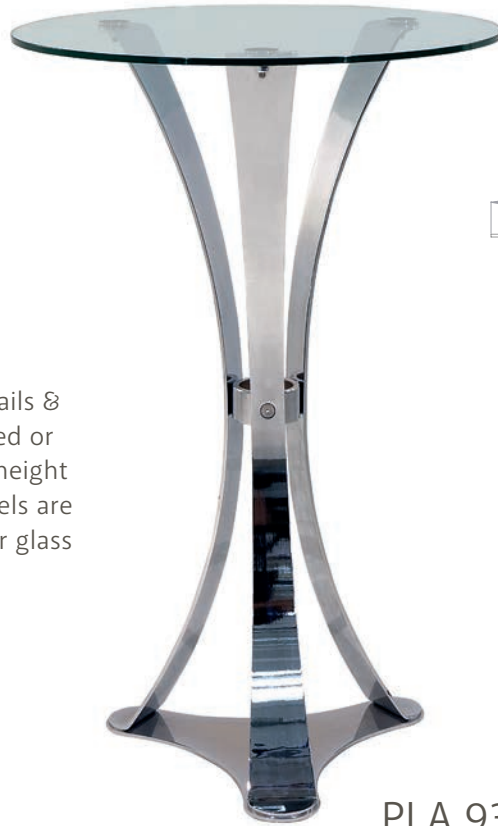

PLA 932
ø70 cm

Tempered Glass

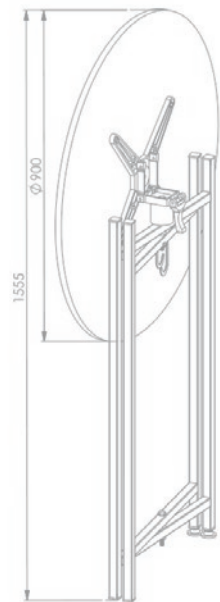
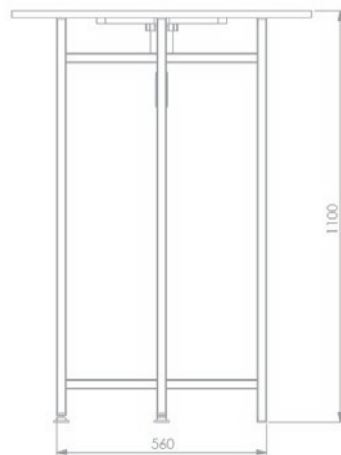

PLA 774

- ø60 cm MDFLAM + PVC
- ø70 cm MDFLAM + PVC
- ø80 cm MDFLAM + PVC
- ø90 cm MDFLAM + PVC
- ø60 cm Temperli Cam / Tempered Glass
- ø70 cm Temperli Cam / Tempered Glass

FOLDABLE DISPLAY TABLES



ABKSM 182x60

Open
8x76x112/64x177cm

ABKSM 182x60

Closed
84x182x174cm



ABKSM ø180

Open
ø182/42x74/112x107x110cm

ABKSM ø180

Closed
48x182x113 cm



PROJECTION TABLES



PRJ 45x103

Closed
45x48,6x66/90 cm

Adjustable height between
66-90 cm



PRJ 45x103

Open
45x103x66/90 cm

BUFFET TABLES



△ ABKB-M
90x90 cm

MDF lam top



□ ABKB-B
90x90x75 cm

6mm Frosted tempered glass



C

6 mm transparent tempered glass, buffet table with aluminium edges

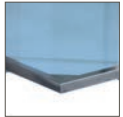

B

6 mm frosted tempered glass, buffet table with aluminium edges

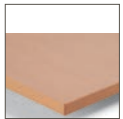



M

MDF lam panels, buffet table with PVC edges

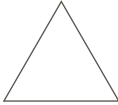
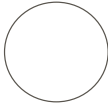

CODES OF TABLES

Diagram	Code
	ABKB 90x90x60 ABKB 90x90x75 ABKB 90x90x90 ABKB 90x90x105 ABKB 90x90x120
	ABKB 90x180x60 ABKB 90x180x75 ABKB 90x180x90 ABKB 90x180x105 ABKB 90x180x120
	ABKB Ø 180/2x60 ABKB Ø 180/2x75 ABKB Ø 180/2x90 ABKB Ø 180/2x105 ABKB Ø 180/2x120
	ABKB △ 90x60 ABKB △ 90x75 ABKB △ 90x90 ABKB △ 90x105 ABKB △ 90x120
	ABKB Ø 180x60 ABKB Ø 180x75 ABKB Ø 180x90 ABKB Ø 180x105 ABKB Ø 180x120

*ABKB büfe masa ayakları paslanmaz çelik ya da epoksi boyalı olarak üretilebilir. Lütfen sipariş esnasında rengi belirtiniz.

*ABKB buffet table legs can be produced in stainless steel or epoxy powder coated. Please specify the colour while ordering.

□ ABKB-C

90x90x75 cm

6 mm Şeffaf temperli cam

6mm Transparent tempered glass

BUFFET TABLES

NESTING TABLE CODES

Şema Diagram	Kod Code
	ABKBE 130x65x70 ABKBE 140x70x75 ABKBE 150x75x80



ABKBE
130x65x70 cm
140x70x75 cm
150x75x80 cm





STAGES

PDY -300 serie is very strong and have secure steel construction. Easy to carry without trolley with its own wheels. It has a mechanism that disable wheels after mounted. Epoxy powder coated steel frame. Top panel can be of laminate or carpeted (must be specified when ordering). When the unit is folded, legs are automatically opened. All podium models are with adjustable height.



STAGE CLASSIC

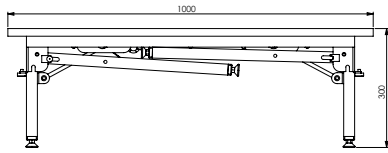

PDY 112
100x100x30/60 cm
Laminat Parke + PVC
Laminated Parquet + PVC

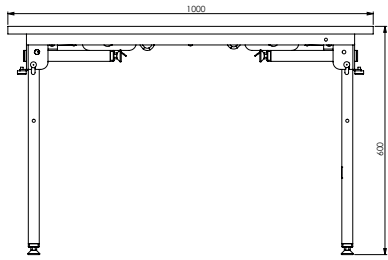

Model	Kod	Dimensions(cm)	Top Panel
Classic	PDY 112	100x100x30/60	Laminat Parke+PVC / Laminated Parquet+PVC
Classic	PDY 122	100x100x30/60	Halı+Alüminyum / Carpet+Aluminium
Classic	PDY 131	100x100x30/60	Mineflo+Alüminyum / Mineflo Cover+Aluminium
Classic	PDY 132	100x100x30/60	Mineflo+PVC / Mineflo Cover+PVC

STAGE WINGY



PDY 321
122x244x40/60 cm

Carpeted + Aluminium edge

PDY 521
183x244x40/60 cm

Carpeted + Aluminium edge

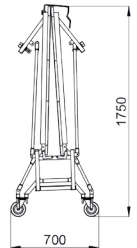
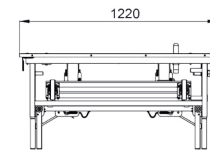
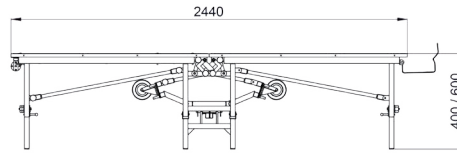

STAGE WINGY



Model	Kod	Dimensions(cm)	Top Panel
WINGY	PDY 311	122x244x40/60	Laminated Parquet + PVC
WINGY	PDY 321	122x244x40/60	Carpet + Aluminium
WINGY	PDY 331	122x244x40/60	Mineflo Cover + Aluminium
WINGY	PDY 332	122x244x40/60	Mineflo Cover + PVC
WINGY	PDY 511	183x244x40/60	Laminated Parquet + PVC
WINGY	PDY 521	183x244x40/60	Carpet + Aluminium
WINGY	PDY 531	183x244x40/60	Mineflo Cover + Aluminium
WINGY	PDY 532	183x244x40/60	Mineflo Cover + PVC

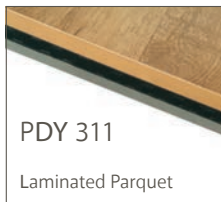

Velcro for skirting on the sides. Skirting is not included in prices.



STEPS



3 Steps with railing



2 Steps with railing



Steps with double railing



Model	Code	Dimensions(cm)	Top Panel
Steps	PDM 122	100x60x20/40	MDF lam
Steps	PDM 132	100x90x20/40/60	MDF lam
Railing	PDK 122	H:116	2 steps
Railing	PDK 132	H:132	3 steps

*If carpet covering is required, must be specified while ordering.

PDM 132

1000x900x200/400/600 mm

STAGE TRANSPORT TROLLEY

BMT 211

185x75x109 cm



Only to transport stage Classic model.
The other models have their own wheels.



DANCE FLOOR

Light and enduring plywood panels on strong aluminium frames. On top of panels there are laminate parquets 8 mm (12000 taber). Bottom is varnished with a strong varnish against humidity. Due to aluminium circular cross section frames (exclusive patent of our company) the dance floors do not move or slide. Therefore, no need to be squeezed with a screw bolt

DNP 111
870x870x30 mm



DNP 112
Edge

DNP 113
Edge



Aluminium border trim.

DANCE FLOOR TRANSPORT TROLLEY

Designed to transport dance floors. Capacity 23 panels.

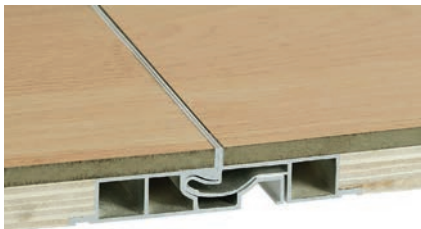

Locking System (Patented)



DNP 311
75x115x100cm

LECTERNS

Evinoks have a very wide range of lecturer tables. Height adjustable as per speakers height. Logo can be mounted to personalize your lectern.



Side shelf.



- A01
with lighting
- M01
Motorized
- A01 - M01
with lighting and motorized



KUR 162
62x60x120/142 cm



KUR 172
66,5x65x122/133 cm



KUR 152
62x47,5x117 mm
KUR 152 - A01
with lighting

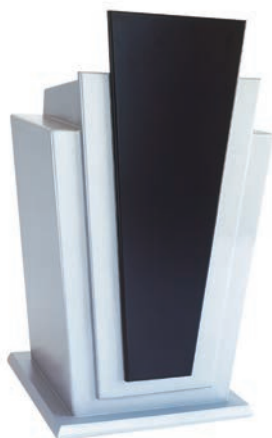

KUR 213
66x60x117 cm



KUR 112
60x60x120 cm



KUR 132
60x60x120 cm

PARAVAN FOLDING SCREEN



Panels are easily fixed with
snap fasteners.



Designed for room dividing or screening off areas. Easy and practical folding ensures a minimum storage space. Wheels with break provide stability.



PRK 521
443x72x175 cm



Folded Screen



PRK 511
443x72x175 cm

Code	Dimensons	Panel Quantity	Covering Material
PRK 311	282x1x72x175	3	MDF LAM
PRK 511	443x1x72x175	5	MDF LAM
PRK 711	605x1x72x175	7	MDF LAM
PRK 321	282x1x72x175	3	KUMAŞ / FABRIC
PRK 521	443x1x72x175	5	KUMAŞ / FABRIC
PRK 721	605x1x72x175	7	KUMAŞ / FABRIC

Sound absorber fabric upon request.



* While ordering you have to specify the sound absorber feature.





BARRIER & ROPES



PRY 211

Gold



PRY 212

Silver

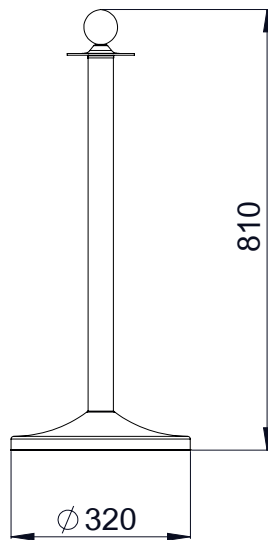

BRK 249

150 cm

Barrier ropes (Black)



BRK 250

150 cm

Barrier ropes (Dark Blue)



BRK 251

150 cm

Barrier ropes (Red)



FABRİKA / FACTORY

Demirtaş Organize Sanayi Bölgesi
Mimoza Sokak No: 5 16245
Bursa / TÜRKİYE
T. +90 224 262 14 00 (Pbx)
F. +90 224 262 14 14 - 15

MARMARA BÖLGE MÜDÜRLÜĞÜ

Gsm. +90 532 507 28 11

ANADOLU BÖLGE MÜDÜRLÜĞÜ

Gsm. +90 549 549 33 43

AKDENİZ BÖLGE MÜDÜRLÜĞÜ

Gsm. +90 533 469 13 25

EGE BÖLGE MÜDÜRLÜĞÜ

Gsm. +90 549 661 12 34

www.evinoks.com.tr



Stand. Standartları, Kalite ve Güvenlik



Middle East Distributor

INFINITY HOTEL SUPPLIES LLC
Mohd. Obaid Al Majid Building, Marrakech St,
Dubai, UAE
sales@infinityhs.ae
+971 55 668 6354, +971 4 263 9688

GRAFİK TASARIM
Başka Tanıtım

BASIM YERİ
A4 Ofset Matbaacılık San.ve Tic.Ltd.Şti.

BASIM TARİHİ
30/04/2017



www.kosgeb.gov.tr